

# Performance Analysis of a Three-Phase Induction Motor with Capacitance Injection

A.A. Jimoh, *member IEEE* and D.V. Nicolae, *member IEEE*

Department of Electrical Engineering, Tshwane University of Technology

Private Bag X07, 0116 Pretoria North, South Africa

[jimohaa@tut.ac.za](mailto:jimohaa@tut.ac.za)

[danaurel@yebo.co.za](mailto:danaurel@yebo.co.za)

**Abstract** — In this paper a static switched capacitor with an auxiliary three-phase stator winding, which is only magnetically coupled to the stator main winding, is explored for improving the starting and operating power factor of a three-phase induction motor. The scheme improves the power factor of the motor without compromising significantly on other performances. Important advantages of the scheme include preventing harmonics in the line current, and eliminating regeneration possibility as well as preventing high inrush currents at starting.

**Index Terms** — Three-phase machines, Induction motors, Reactive compensation, Power factor correction.

## I. INTRODUCTION

Generally, an induction machine requires reactive power for operation. Thus its power factor is inherently poor, and it is worse especially at starting and when running with light loads. The power factor of an induction machine has been observed to be poor also when operating with power electronics converter.

At starting the input power to an induction motor is mainly reactive. It draws 6-10 times its rated current at about 0.2 power factor, and takes a second or so to come to speed, where the power factor significantly improves to above 0.6, depending on the load. This initial high current at a poor power factor normally affects the loads nearby and limits the application range of the machine. A motor with a high start-stop operation, in addition to being a nuisance to the surrounding loads, will have an overall poor power factor performance.

To improve the power factor of induction machine requires a means of reactive power compensation. Several techniques, which have been suggested for achieving this, include [1] synchronous compensation, fixed capacitors, fixed capacitor with switched inductor, solid-state power factor controller, and switched capacitors. Most of these techniques suffer certain drawback or another. The synchronous compensation technique is complex and not cost effective. Other techniques incorporate directly the connection of capacitors, which lead to the problems of voltage regeneration and over-voltages, and very high inrush current during starting. Techniques

incorporating controlled switches in the stator winding circuit generate large harmonic currents in the machine and in the line. A variety of stator winding configurations incorporating capacitors have also been proposed [2]. Most of these configurations introduce asymmetry problems in the machine.

The static switch capacitor has also been used for single-phase induction motors [3-5] with inconclusive results.

## II. PROPOSED MODEL

In this paper a method is proposed which overcomes most of the drawbacks noted above. The method makes use of two three-phase windings on the stator. One set, the main winding, is connected in star to the source. The other set is in delta configuration and has the SSC connected to it as shown in Fig. 1. It is only magnetically coupled to the main winding. All windings have the same shape and pitch, but may have different turn numbers and wire sizes; usually smaller in order to be accommodated in the slots together with the stator. The windings are arranged in slots such that there is no phase shift between the two windings.

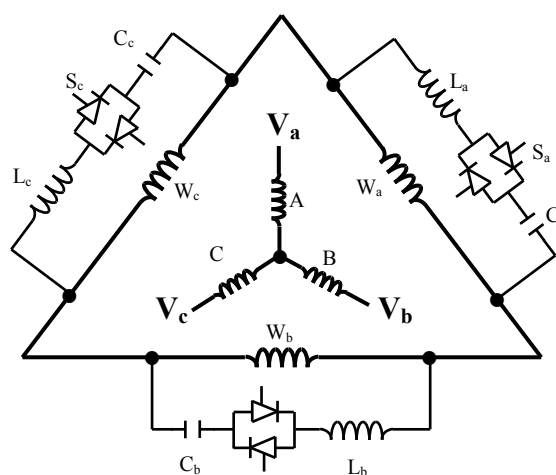

Fig. 1: The high power factor three phase induction machine

The static switching is such that only the required level of reactive compensation is allowed. A SSC is

connected in parallel to each phase of the delta winding so as to prevent high inrush of currents during switching. The fact that the capacitor circuit is only magnetically coupled to the main winding eliminates the injection of harmonics into the system.

After delta-star transformation of the auxiliary windings and based on transformer approach of the induction motor, the electric model per phase of the proposed machine is shown in Fig. 2. The couplings between the elements of the machine are presented as ideal transformers with  $k_a$ : the turn's ratio between auxiliary winding and stator ( $k_a < 1$ ),  $k_r$ : the turn's ratio between rotor and stator ( $k_r < 1$ ) and  $k_{ra}$ : the turn's ratio between rotor and auxiliary winding ( $k_{ra} < 1$ ).

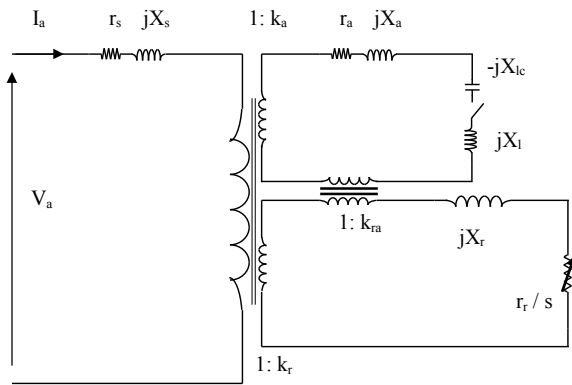

Fig. 2 Per-phase model

The elements from the Fig. 2 are:

- $r_s$  – stator series resistance
- $X_s$  – stator leakage reactance
- $r_r$  – rotor resistance
- $X_r$  – rotor leakage reactance
- $r_a$  – auxiliary winding resistance
- $X_a$  – rotor leakage reactance
- $s$  – the slip
- $X_c$  – capacitive reactance
- $X_{lc}$  – very small inductive reactance for di/dt thyristor protection

### III. SIMULATION MODEL

It is going to be further proven that the capacitive reactance introduced in the circuit via the thyristor switch improves the power factor of the motor. In this regard a simulation model has been built.

The simulation model (see Fig. 3) has been built using Matlab-Power System Block Set. It is closely following the electric model from Fig. 2. The parameters of a 4 kW induction motor have been used for validation of the proposed model.

The key element in this model is the variable resistor of the rotor which depends upon the slip; the simulation block has been performed in the same way

as the principle of variable inductor from the demo library. The variation of the slip – the second important simulation parameter has been realized using a repeating sequence generator which varies from 1 (corresponding to the initial starting moment) to the respective value for a given torque.

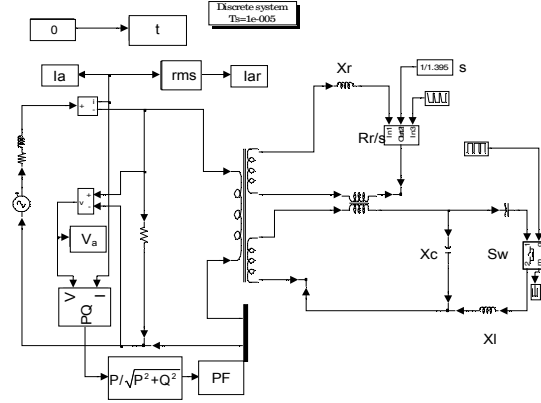

Fig. 3 Simulation model

In order to find the torque – speed/slip variation, a set of simulations have been done using the default 4 kW induction motor – four poles model supplied from a 380 V / 50 Hz three-phase source with 100 kVA short-circuit level and  $X/R = 7$ . By giving different values for torque ( $T_m$ ) the other parameters of the motor have been deduced as presented in the Table I.

TABLE I  
4 KVA INDUCTION MOTOR PARAMETERS

$T_m$ (N.m)	$I_{sa}$ (A)	$n$ (rpm)	$s$	PF
0	3.84	1498.7	0.00087	0.06
1	3.85	1496.2	0.00253	0.12
5	4.1	1485.6	0.0096	0.36
10	4.72	1471.7	0.01887	0.58
15	5.63	1457.2	0.02853	0.717
18	6.35	1448	0.03467	0.772

#### A. Steady state parameters

Fig. 4 shows the steady state parameters of the motor for 1 N.m torque and  $C = 60 \mu F$  and Fig. 5 same parameters for  $C = 100 \mu F$ .

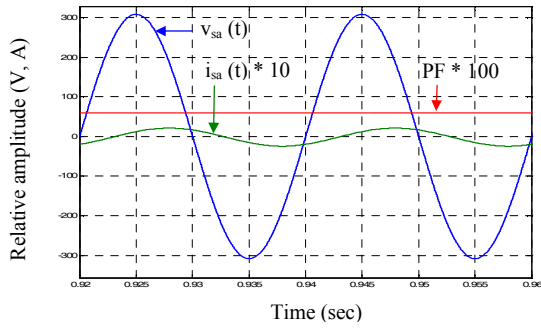

Fig. 4 Steady state parameters for  $C = 60 \mu\text{F}$

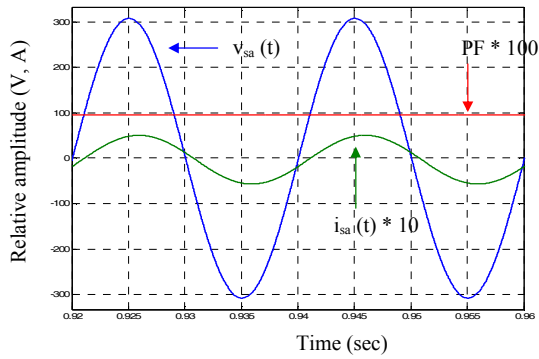

Fig. 5 Steady state parameters for  $C = 100 \mu\text{F}$

As can be noticed from the above figures, the capacitance improves the power factor.

An optimum value for the injection capacitance has been considered the value which produces a power factor of approximately 0.95 lagging. If a perfect unity power factor is considered, then any variation of the electrical, mechanical or thermal parameters could produce a leading power factor which will increase significantly the current drawn.

### B. Minimum capacitance determination

Next set of simulation has been performed to determine the value of the compensating capacitor when the motor naturally runs at “high power factor” for a torque of 18 N.m. The “slip generator” has been set to produce a variation between 1 and 0.03467 with duration of 0.3 sec. Then the capacitor has been varied until the power factor came, lagging, close to unity. The results are presented in the Table II and the optimum value should be 40  $\mu\text{F}$ .

TABLE II  
POWER FACTOR VERSUS COMPENSATING CAPACITOR  
MINIMUM VALUE DETERMINATION

C ( $\mu\text{F}$ )	0	10	20	30	40	50	60
$I_{sa}$ (A)	6.35	6.42	6.62	6.95	7.44	8.1	8.92
PF	0.77	0.82	0.87	0.92	0.95	0.97	0.99

### C. Maximum capacitance determination

In the previous set of simulations a “high” slip with a “high” power factor (PF) has been taken and the capacitance  $C$  had been increased for power factor improvement while the firing angle was zero. Table III presents the power factor as a function of the compensating capacitor for a 1 N.m torque; the “slip generator” has been set to produce a variation between 1 and 0.00253 with duration of 0.2 sec. When the capacitor has been increased above 120  $\mu\text{F}$ , the power factor became leading and the current in steady state increased above inrush current. Thus, the optimum value for the capacitor is 100  $\mu\text{F}$ .

TABLE III  
POWER FACTOR VERSUS COMPENSATING CAPACITOR  
MAXIMUM VALUE DETERMINATION

C ( $\mu\text{F}$ )	0	20	40	60	80	100	120
$I_{sa}$ (A)	2.25	2.05	1.78	1.62	2.05	3.85	4.9
PF	0.13	0.19	0.33	0.61	0.91	0.96	0.99

### D. Starting current

To validate the reduction of the starting current, the torque has been set for 18 N.m which means  $s = 0.0347$ , the starting time 0.3 sec and compensating capacitor  $C = 50 \mu\text{F}$ . The result is shown in Fig. 6 and, as can be noticed, the over-current is about 15 percentages higher.

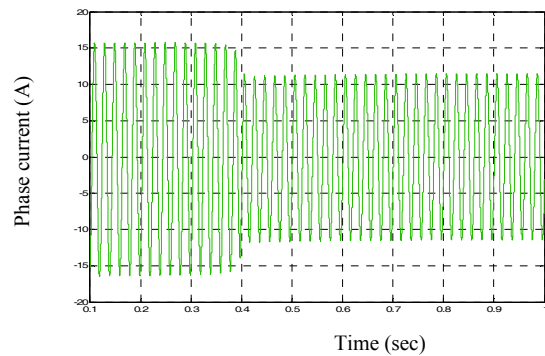

Fig. 6 Starting current

### E. Capacitor switching

From the above simulations, it results that the value of the compensating capacitor should be between 40 and 100  $\mu\text{F}$ .

The next step into validation of the proposed model was to determine the effect of the switching of the capacitor upon the parameters of the motor. For

this purpose, C has been split in two parallel capacitors: a fixed value of 40  $\mu\text{F}$  and a 60  $\mu\text{F}$  in series with the switch. Then, the torque was at 1 N.m and the firing angle ( $\alpha$ ) has been adjusted between  $0^\circ$  (corresponding to 1 msec) to  $162^\circ$  (corresponding to 9 msec). The results are presented in the Table VII.

TABLE IV  
POWER FACTOR VERSUS FIRING ANGLE

$\alpha$ ( $^\circ$ )	0	36	54	72	90	108	126	144	162
$I_{sa}$ (A)	3.85	3.8	5.2	3.32	2.51	4.8	1.87	1.76	1.82
PF	0.96	0.95	0.68	0.88	0.8	0.46	0.68	0.51	0.49

Fig. 7 shows the power factor variation versus firing angle.

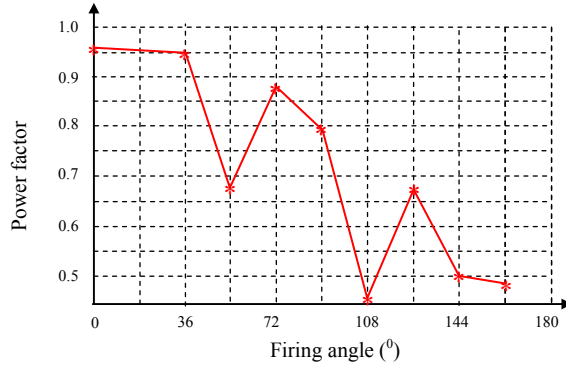

Fig. 7 Power factor versus firing angle

#### IV. SWITCHING INFLUENCE

As presented above the variation of the firing angle produced the variation of the equivalent capacitor and consequently the power factor could be adjusted which is the main purpose of this proposed model. It also can be observed that the lumped parameters model has a smooth variation of the power factor versus firing angle while the model based on linear transformer has a very non-linear variation. This fact can be explained due to the complexity of the model which implies some resonances; this is also followed by the drawn current.

One other aspect to be mentioned is the level of distortions introduced by the switching into the supply current. For exemplification, the firing angle of  $90^\circ$  has been chosen. Fig. 8 shows that the shape of the supply ( $i_{sa}$ ) current is not affected much and the harmonics content is quit small (see Fig. 9), while the current through the switch ( $i_{csw}$ ) displays relative high distortions. This, as stated in the introduction is due to

inductive coupling between auxiliary winding and the stator.

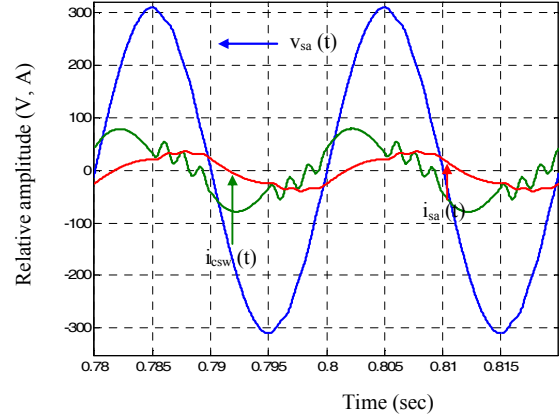

Fig. 8 Supply and switched capacitor currents

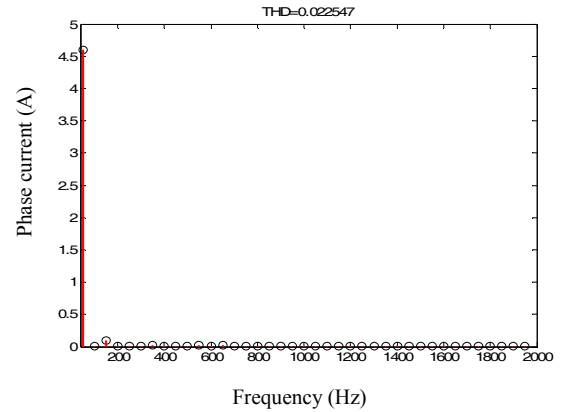

Fig. 9 Supply current: harmonic content

At a closer look, the main component which affects the distortions of the supply current is the third harmonic that is very much diminished when one considers the three-phase model.

#### V. EXPERIMENTAL RESULTS

In order to practically validate the proposed model, a motor has been modified by adding the auxiliary windings. The same scheme of splitting the capacitor C in two: a fixed value of 40  $\mu\text{F}$  and a 60  $\mu\text{F}$  in series with the switch has been used. The mechanic load has been set for rated and the firing angle adjusted from  $0^\circ$  to  $180^\circ$ .

The starting current has been observed for an unmodified motor (see Fig. 10) and for a modified motor (see Fig. 11). In both oscilloscope-graphs, the time-base was 0.5 sec/div and the vertical was 20 A/div. It is possible to notice the inrush current is very

much reduced for the modified motor while the steady state is a little bit higher.

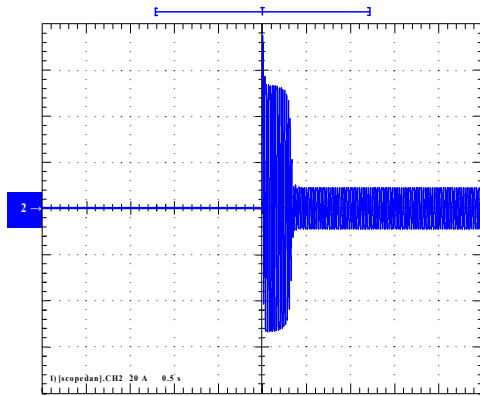

Fig. 10 Unmodified motor: starting current

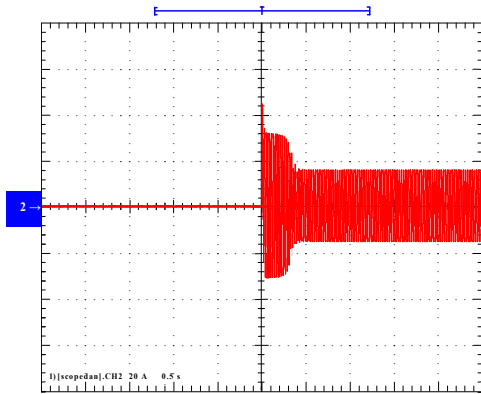

Fig. 11 Modified motor: starting current

The results of measuring the motor are presented in the Table V. Parameters  $V_a$  and  $I_a$  are the voltage and current per phase. The motor has been loaded with 50 % of the nominal torque.

TABLE V  
MEASURED PARAMETERS

$\alpha(^{\circ})$	0	36	72	108	144	180
$V_a(V)$	220	220	220	220	220	220
$I_a(A)$	1.61	1.65	1.75	1.96	1.84	1.86
P(W)	891	875	839	818	787	764
S(VA)	1061	1093	1156	1297	1215	1232

The power factor and active power per phase have been observed and the results are presented in Fig. 12 and 13 respectively. It is to be noticed the same very non-linear variation of the power factor versus firing angle. But the active power drawn from the supply it is a little bit higher due to the extra current flowing through auxiliary winding.

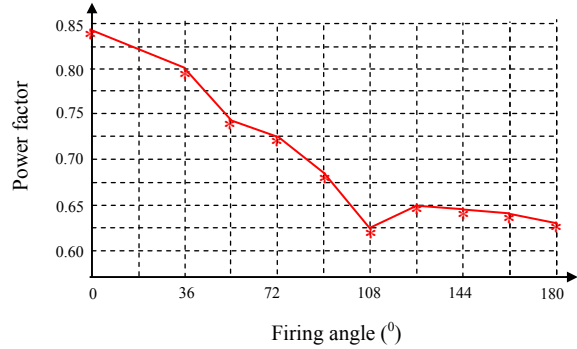

Fig. 12 Power factor versus firing angle; experimental results

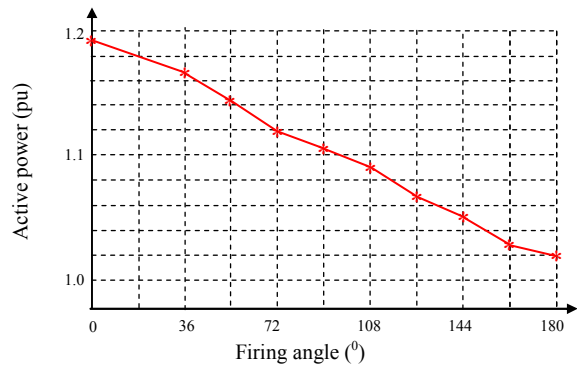

Fig. 13 Active power versus firing angle: experimental results

It has been also of interest the influence of the switching upon the curve torque versus load; the results are presented in Fig.14; the influence of the switching is very small.

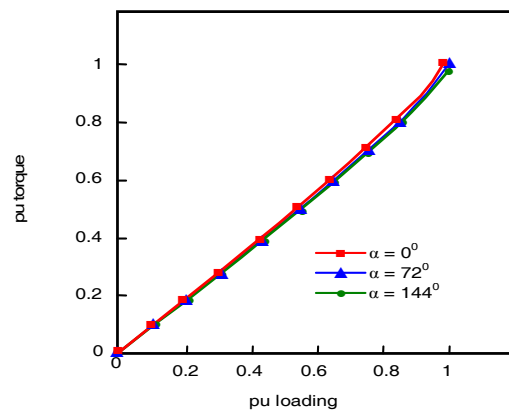

Fig. 14 Curves torque versus loading for various angle

## VI. CONCLUSIONS

In this paper, a three-phase induction motor with an auxiliary three-phase stator winding, which is only magnetically coupled to the stator main winding and capacitance injection is explored for improving the starting current and operating power factor. The scheme improves the power factor and starting current while keeping a low level of distortion of the supply current.

The efficiency of this new motor is not satisfactory yet and future research should be done to optimize it. Also experimentations of the proposed modification on various ranges of power should be done.

## REFERENCES

- [1] M.A. El-Sharkawi, S.S. Venkata, T.J. Williams, and N.G. Butler, "An Adaptive Power Factor Controller for Three-Phase Induction Generators", Paper 84 SM 672-2 presented at the *IEEE/PES 1984 Summer Meeting*, Seattle, Washington, July 15-20 1984.
- [2] Wu Hanguang, Chen Xiumin, Lu Xianliang, and You Linjuan, "An Investigation on Three-phase Capacitor Induction Motor", *Proceedings of the Third Chinese International Conference on Electrical Machines*, August 29-31, 1999, Xi'an, China, pp. 87-90.
- [3] T.A. Lattemer, D.W. Novotni and T.A. Lipo, "Single-Phase Induction Motor with an Electronically controlled Capacitor", *IEEE Transaction on Industry Applications*, Vol. 27, No.1, Jan./Feb., 1991, pp. 38-43
- [4] E.I. Panov, H.L. Patev, G.S. Donev, T.T. Gatev and V.P. Ivanova, "Research into a class of reactive one-port with controlled parameters", *Proceedings of National Conference "Electronic Technologies"*, Sozopol, Bulgaria, 1995
- [5] J. Faiz and M. Tarafdar-Haque, "Minimization of starting time and improvement of performance of a capacitor-run single-phase induction motor", *Proceedings of ELMA Conference*, Varna, Bulgaria, 1993, pp. 147-152